



151-1938

IGM LAGUNA 1938 SUPERMAX DRUM SANDER

Manual



Producer:

Laguna Tools Inc
744 Refuge Way, Suite 200
Grand Prairie, Texas 75050 USA
Phone: +1 800-234-1976
Website: www.lagunatools.com

Distributor:

IGM nástroje a stroje s.r.o.
Ke Kopanině 560, 252 67, Tuchoměřice
Czech Republic, EU Phone:
+420 220 950 910
E-mail: sales@igmtools.com Website:
www.igmtools.com



PDF ONLINE
www.igmtools.info

2024-08-30

151-1938 LAGUNA Drum Sander Manual EN v2.01.01 A4ob



EC DECLARATION OF CONFORMITY

We
(Manufacturer)

Laguna Tools Inc.
2072 Alton Parkway, Irvine, California 92606, USA

Declare that the product name: Woodworking

Drum Sander Model Name : 71632,

71938, 71938-D, 72550

Conform with the essential safety requirements of the relevant European Directive:

- Machinery Directive 2006/42/EC
- Electromagnetic Compatibility Directive 2014/30/EU

The person who compile technical file established within
the EU: Name: IGM nastroje a stroje s.r.o.

Address: Ke Kopanine 560, Tuchomerice , CZ-252 67

Tel.: +420 220 950 910

Email: sales@igmtools.com

Mounting and connecting instructions defined in catalogues and technical construction files must be respected by the user.

They are based on the following standards:

- EN ISO 12100:2010 Safety of Machinery - General principles for design / Risk Assessment and Risk reduction.
- EN 60204-1:2006+AC:2010 Safety of machinery – Electrical equipment of machines, part 1 : General requirements.
- EN 13849-1:2015 Safety of machinery – Safety – related parts of control systems Part 1: General principles for design
- EN 50370 -1:2005 Electromagnetic compatibility (EMC) – Product family standard for machine tools – Part 1: Emission.
- EN 50370 -2:2003 Electromagnetic compatibility (EMC) – Product family standard for machine tools – Part 2: Immunity.
- EN 61000-4-2: 2009 Electrostatic (ESD)
- EN 61000-4-4: 2012 Electrical fast transient/burst requirements (EFT/Burst)
- EN 61000-4-6: 2014 Immunity to conducted disturbances, induced by radio-frequency fields (CS)

Responsible for the documentation: Head Product Management, Laguna

Tools Inc. Name : Torben Helshoj

Responsibility : President

Authorized

Signature



Date : Oct. 15, 2021

Place : Laguna Tools Inc.

2072 Alton Parkway, Irvine, California 92606, USA

Telephone: +1 800 234-1976

Fax: +1 949 474-0150

EN - English

Operating Instructions (Original)

Dear Customer,

many thanks for the confidence you have shown in us with the purchase of your new Laguna Tools machine. This manual has been prepared for the owner and operators of an **IGM LAGUNA 1938 SuperMax Drum Sander** to promote safety during installation, operation and maintenance procedures. Please read and understand the information contained in these operating instructions and the accompanying documents. To obtain maximum life and efficiency from your machine, and to use the machine safely, read this manual thoroughly and follow instructions carefully. We wish you many work and personal pleasures when working with the Laguna Tools machine.

Table of Contents

1. Declaration of Conformity

2. Warranty

3. Safety Authorized Use General Safety Notes Hazards
Grounding Instructions

4. Machine Specification

5. Transport and Setup
Instruction for Transport and Setup

6. Setting and Adjustment
Drum Sander Adjustment Installing and Wrapping Abrasives

7. Machine Operation

8. Maintenance

9. Troubleshooting

10. Head Assembly

11. Wiring Diagram

12. Open Stand Assembly

13. Conveyor and Motor

1. Declaration of Conformity

We declare that this product is in compliance with the directive and the standard mentioned on the previous page of this manual.

2. Warranty

The company IGM Tools & Machinery s.r.o. always strives to deliver a product of high quality and efficiency.

The application of the warranty is governed by the valid Business Conditions and the Warranty Conditions of the company IGM Tools & Machinery s.r.o.

3. Safety

3.1 Authorized Use

This machine is designed for sanding wood and wooden products only.

Sanding of other materials is not permitted but can be performed in specific cases only after consulting the manufacturer.

The machine is not suitable for wet sanding. The required minimum age must be observed.

The machine must only be used in a technically perfect condition.

In addition to the operating instructions, also read the safety requirements and your country's applicable regulations.

You should observe the generally recognized technical rules and safety requirements concerning the operation of woodworking and metalworking machines.

Neither the manufacturer nor the supplier is liable for damage resulting from unauthorized use of the machine. Responsibility is transferred exclusively to the operator.

3.2 General Safety Notes

Woodworking machines can be dangerous if not used properly.

Read and understand the entire operating manual before attempting assembly or operation.

Protect this operating manual from dirt and humidity and pass it over to the new owner if you part with the machine.

No changes to the machine may be made.

Daily inspect the function and existence of the safety appliances before you start the machine. Correct all defects or damaged safety appliances immediately. The machine must only be used in a technically perfect condition.

Protect long hair with a cap or hair net. Remove all loose clothing, rings, watches and other jewelry. Wear safety shoes; never wear leisure shoes or sandals. Follow personal protection guidelines.

Do not wear gloves while operating this machine!

Install the machine so that there is sufficient space for safe operation and workpiece handling.

The machine must be bolted on firm and levelled surface and must be properly lighted.

Always wear a protective mask in a dusty environment. Keep work area well lighted.

Make sure the machine stands on a board.

Make sure that the power cord does not impede work. Keep work area clean. Never reach into the machine while it is operating or running down. Stay alert! Give your work undivided attention. Use common sense. Do not operate the machine under the influence of drugs, alcohol or any medication.

Keep children and visitors a safe distance from the work area. Never leave a running machine unattended. Before you leave the workplace switch off the machine.

Do not use the machine in a damp environment and do not expose it to rain.

Wood dust is explosive and can also represent a risk to health. In particular dust from tropical woods and hardwoods like beech and oak, is classified as a carcinogenic substance.

Focus on the position of your fingers and other parts of your body when working.

Do not start the machine without safety appliances. It is important to clamp all workpieces.

Machine only stock which rests securely on the table.

Do not remove chips and workpiece parts until the machine is at a standstill.

Minimum workpiece length is 60 mm. Do not stand on the machine.

Repair work on the electrical installation may be carried out by a qualified electrician only.

Have a damaged or worn power cord replaced immediately. Have a damaged abrasive replaced immediately.

3.3 Hazards

When using the machine according to regulations some remaining hazards may still exist.

Loose sanding belt can cause injury. The workpiece may bounce off the sanding belt and turn against the machine operator. Danger of thrown workpiece.

Dust and noise can be health hazards.

Be sure to wear safety goggles, ear protection and dust mask. Use a suitable dust exhaust system. Defective or damaged sanding belt can cause injury. Do not use damaged or worn power cord.

3.4 Grounding Instructions

Connection cord:

In the case of a defect or malfunction, grounding provides a path of least resistance to electric current, reducing the risk of electric shock. The machine is supplied with connection cord with a guard wire and euro plug. The plug must only be connected to an appropriate outlet in accordance with all local codes and regulations.

- Do not modify the plug, if it does not fit into the socket. Contact a qualified electrician and have the appropriate socket installed.
- Improper connection may result in a risk of electric shock. Ground wire is an insulated wire with a green surface with/without yellow stripes. If the cord or plug needs to be repaired, contact a qualified electrician.
- Damaged cords should be repaired immediately and only by a qualified electrician.
- Use only three-wire cables with a euro plug and an appropriate socket.

4. Machine Specification

Type:	1938 SuperMax
Power:	230 V / 50 Hz / 1 Phase
Current at Full Load:	8,9 A
Power Output:	1300 W
Conveyor Belt Motor:	Direct drive D.C. motor
Speed:	1420 RPM
Feed Speed:	0-3 m/min.
Stock Width at One Pass:	482 mm
Stock Width at Two Passes:	965 mm
Material Thickness min / max:	0,8-100 mm
Drum Size:	127 x 482 mm
Width of Abrasive:	76 mm
Minimum Dust Collector Airflow:	1000 m3/h
Dust Extraction Outlet:	100 mm
Machine Dimensions (LxWxH):	1090 x 670 x 1290 mm
Shipping Dimensions (LxWxH):	1150 x 1150 x 815 mm
Machine Weight:	118 kg
Shipping Weight:	130 kg



1. Height adjustment handle of the drum
2. Shroud
3. Digital Read-out
4. Knob to start feed conveyor and select feed rate
5. Starts and stops drum motor
6. Conveyor table
7. Tension roller contact adjustment
8. Drum carriage

5. Transport and Setup

5.1 Setup

The machine is transported in a shipping package. The machine is designed to operate in closed rooms and must be placed stable on a firm and levelled ground. The machine requires assembling.

Package contents Stand box contents (found inside the main box)

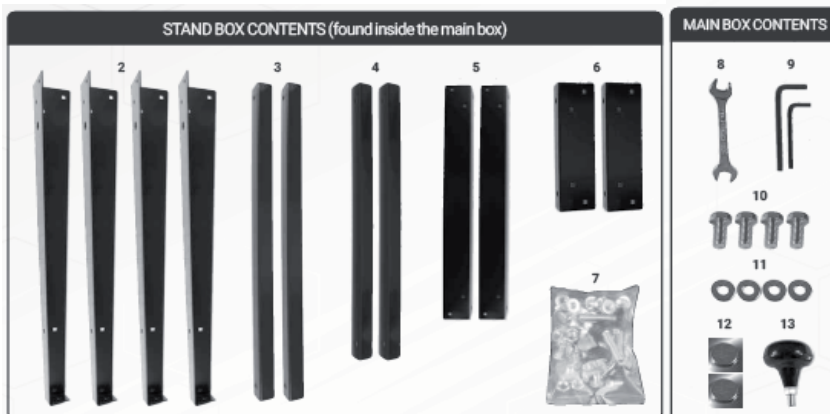

Drum Sander Assembly

Note: For initial stand assembly secure all bolts finger tight. This will allow for easier levelling after the sanding unit is installed on the stand. The holes in the legs are spaced so that the short and long top braces will only line up from one face of each leg.

1. Secure two legs to the outside of each of the two short top cross braces using the supplied carriage bolts and flange nuts.



2. Secure the two long top rails inside of the legs and on top of the short rails.



3. **Note:** Long rail on top of short rail and both rails inside of legs.



4. Connect the second leg sub-assembly to the top long rails.



5. Attach the lower cross braces to the legs. The longer cross braces should sit on top of the short ones.



6. Attach a levelling foot to the bottom of each leg (not required if installing optional caster set).
Note: After final assembly and sander installation, adjust the nuts on the threads as needed to level the stand.



Installing Drum Sander

1. There will be a small container of hardware included with your sander. This container will include everything you need to set up your sander.

2. Open box 1 that contains the main sanding unit. Remove the cardboard liner. Open the plastic bag enclosing the sanding unit.

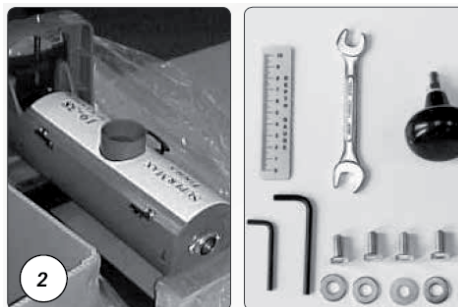

3. Cut each corner of BOX 1 to fold sides flat, providing access to sanding unit.

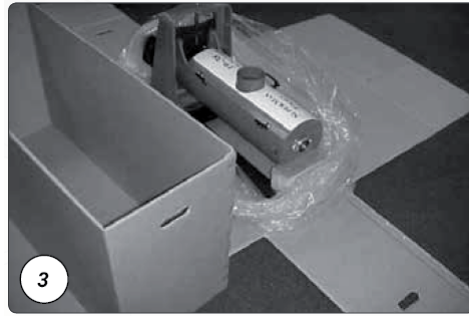

4. With one or two helpers, place the sanding unit on stand or bench (lift points marked).

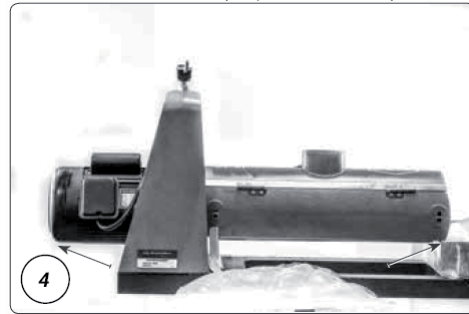

5. Remove the two wooden packing plates from bottom of the sanding unit using the enclosed wrench and keep wrench for future adjustments.

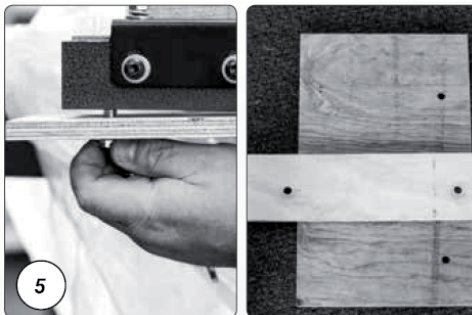

NOTE: These bolts that you just removed from the packing plates will work as your bolts for attaching the sander or as extra bolts for future replacement.

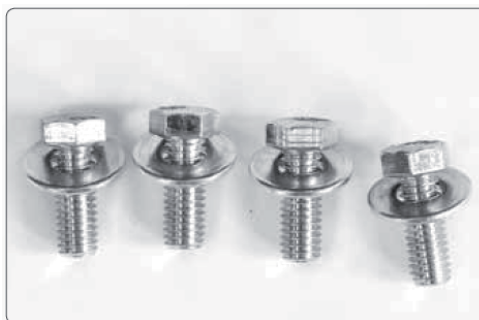

6. Install knob to height adjustment handle. First, finger tighten nut to knob. Thread stud from knob into hand wheel and tighten nut against hand wheel.

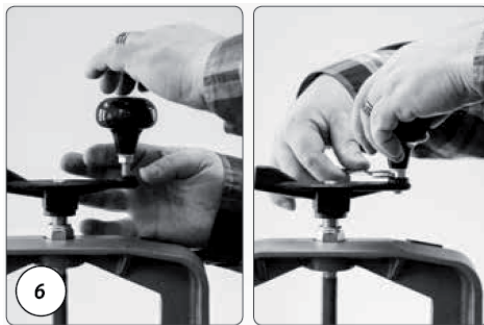

7. Turn the handle and raise sanding head to higher position to remove packing block from under carriage arm.

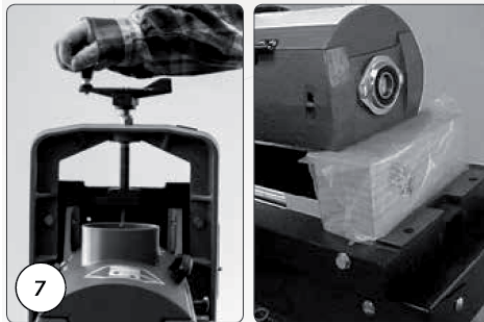

8. To prepare the unit for the installation of the conveyor belt, first remove the 2 bolts on the outboard (left) side of the conveyor belt.



9. Next remove the 2 bolts on the inboard (right) side of the conveyor belt.

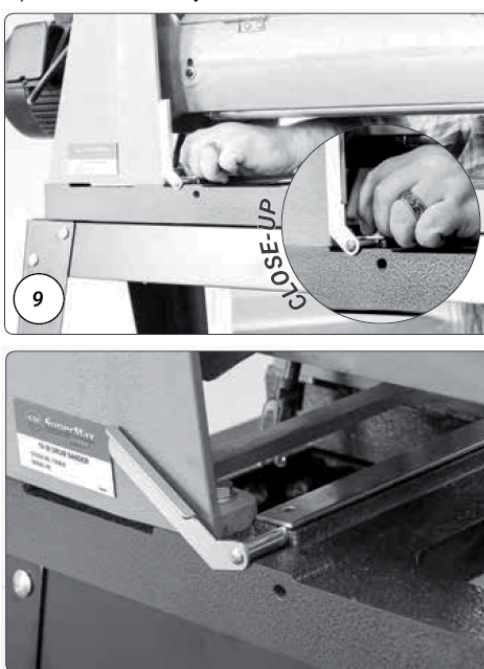

NOTE: Leave the silver plate, which is near the fast lever and under the motor, in place when removing bolts.

10. Open box 2 and remove conveyor from packaging and place on sanding unit. The conveyor motor should be nearest to the main motor and depth gauge.



NOTE: The fast lever should be in the upright position for installation of the sanding unit. The fast lever raises the inboard (right) side of conveyor up. Do not ever tighten the bolts all the way down. The fast lever should always be able to be moved back and forth between and up/down position. The bolts should be tightened, but not so tight that the fast lever doesn't move. The lever should be able to move from the down to up position easily.



11. Install lock washer and flat washer onto two socket heads (or hex head bolts) and install into flange of conveyor bed on inboard (right) (motor side). Keep support plate in place on inboard (right) side and make sure the fast lever is positioned up.

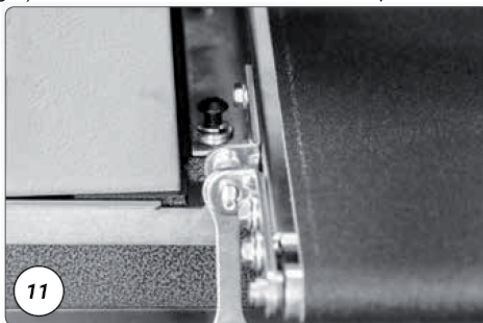

12. Install two lock washers and two flat washers on the studs on outboard (left) side of the conveyor belt, then tighten all nuts and bolts with wrench.

NOTE: Do not completely tighten bolts with fast lever. See note above.



13. Plug the short power cord that is attached to the motor into the outlet on the control box. This cord will provide switched power for the motor when the machine is plugged into the power source.



14. Check your power supply to make sure that it is adequate (230 V, 1Ph required) but do not plug the machine into the power supply until it is fully set-up.

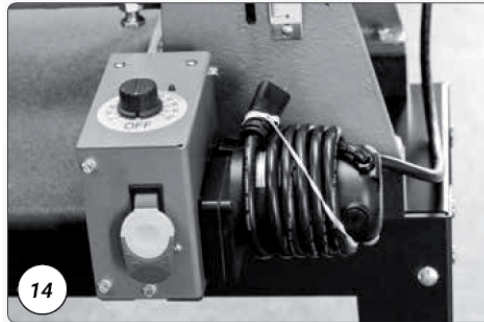

6. Setting and Adjustment

Your sander should now be in place and ready for the final set-up. The sander was adjusted and aligned at the factory. However simple alignment checks will ensure that everything is in perfect order.

Problems can be avoided if these essential checks and set-up procedures are performed prior to operation.

6.1 Setting the Drum Sander Checking Drum Alignment

UNPLUG THE MACHINE FROM THE POWER SOURCE!

During initial setup only. Checking the alignment is necessary to make sure that the drum is parallel.

Before checking the drum alignment make sure that the fast lever between the conveyor motor and the machine is in the up position. The conveyor table bolts on the inboard side should not be so tight that the fast lever does not rotate.

1. Remove the abrasive on the drum. Removing the abrasive is necessary to make sure that the adjustment is as accurate as possible and the texture on the abrasive will make the adjustment imprecise.

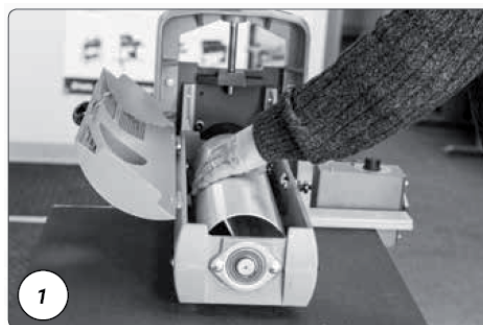

2. Locate the height adjustment handle for raising and lowering the sanding head.



NOTE: The height adjustment handle controls the drum height. Turning the handle raises or lowers the sanding head. One revolution of the handle raises or lowers the head by 1.4 mm.

3. Use a flat, uniform piece of wood as a thickness gauge. Insert it between the conveyor belt and the drum on the inboard (right) side of the machine.

The tension rollers are set just below the drum enough so that items cannot pass easily underneath. Use the height adjustment handle as necessary to ensure that the piece of wood makes contact with the drum.

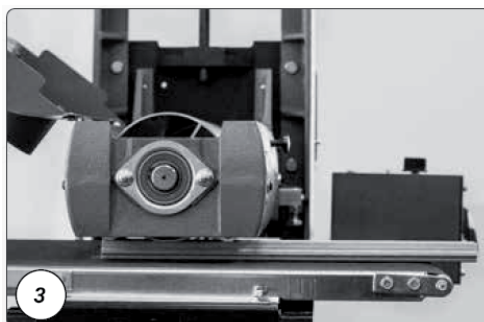

4. After you place the piece of wood between the conveyor belt and the drum, rotate the height adjustment handle up one full turn. After the height has been adjusted the wood piece may be removed.



NOTE: You have to repeat these steps on the outboard (left) side of the machine using the same procedure. As you check look to make sure that the drum is parallel. A simple visual check that the drum is parallel is sufficient.

If the drum is not parallel, loosen the 4 socket head screws A (these screws are along the outboard (left) side of the conveyor belt) and raise or lower the conveyor with the adjustment nut B to achieve parallel alignment. Then tighten the four socket head screws. To achieve parallel alignment on the inboard (right) side of the machine, repeat steps 3 and 4, then adjust the alignment if needed by loosening the 4 socket head screws located along the outboard (left) side of the conveyor and turning the height adjustment nut of the conveyor.

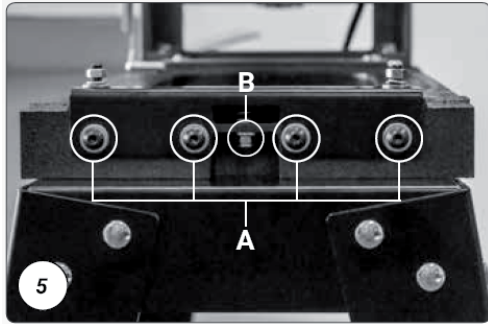

Connecting Dust Collection

Dust collection is necessary for the drum sander. The sander comes equipped with a 100 mm (4") diameter dust exhaust port at the top of the cover. Make sure that the minimum dust requirements are sufficient. To attach to your collection system, install 100 mm (4") hose from your collector. The minimum recommended dust collector capacities is 1000 m³/h. For best results, follow the recommendations of the manufacturer of your dust collector. When connecting dust collector straight pipe is preferred because it is the least restrictive for airflow. If straight pipe is not possible Y's and elbows are preferred because they are less restrictive to airflow than T's.

Note: Some applications will require more dust collection than the recommended minimum.

Power and Electrical Safety

11. Make sure that your power supply is adequate (230 V, circuit breaker 16 A, rating C (16/1/C)). After the dust collection system is in place and the drum alignment is checked your machine is ready to be powered up and operated.

Abrasive Selection Guide

To attach the abrasive to the drum, follow the procedure below.

Grit Common Application

24 GRIT - Abrasive planing, surfacing rough-sawn boards, maximum stock or glue removal
 36 GRIT - Abrasive planing, surfacing rough-sawn boards, maximum stock or glue removal
 50 GRIT - Surfacing and dimensioning boards, trueing warped boards
 60 GRIT - Surfacing and dimensioning boards, trueing warped boards
 80 GRIT - Light dimensioning, removal of planer ripples
 100 GRIT - Light surfacing, removal of planer ripples
 120 GRIT - Light surfacing, minimal stock removal
 150 GRIT - Finish sanding, minimal stock removal
 180 GRIT - Finish sanding only, not for stock removal
 220 GRIT - Finish sanding only, not for stock removal

6.2 Installing and Wrapping Abrasives

Accurate attachment of the abrasive to the drum is critical to achieving the machine top performance. Abrasive strips do not have to be pre-measured. The end of the roll is first tapered and attached to the outboard (left) side of the drum. Then the strip is wrapped around the drum. The second taper is made for attachment to the inboard (right) side of the drum.

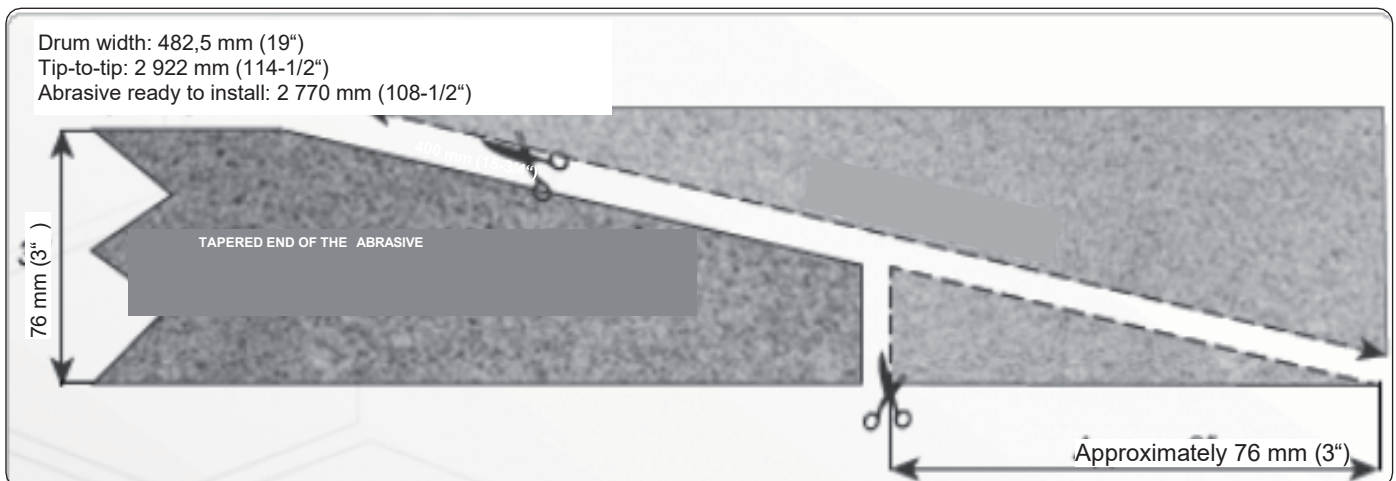

Note: Pre-cut abrasives have been factory tapered to the specific width of your drum. If you are cutting your own abrasive, use the wrap that came on the drum as a template (abrasive side up). The direction of the abrasive grain must also be taken into account. The direction arrow is on the underside of the grinding roll.

Installing and Wrapping Abrasives (continued)

UNPLUG THE MACHINE FROM THE POWER SOURCE!

1. Mark and cut a taper at one end of the roll as shown below. Because the tapered end should use most of the left (outboard) slot width, its end must be trimmed. Start on the left (outboard) side of the drum. Pinch or squeeze the clip lever on the left (outboard) side of the drum. Insert the tapered end through the slot and into the fastener so that it uses most of the width of the slot. Release the clip lever to securely hold the wrap end in the fastener.



2. Wind the abrasive around the drum, being careful not to overlap the windings. The tapered cut of the wrap end should follow the edge of the drum.

Continue to wrap the abrasive in a spiral fashion by rotating the drum with your left hand and guiding the abrasive with your right hand. Successive windings of the wrap should be flush with previous windings without any overlap.



3. Squeeze the clip lever to open the clip and pull the take-up lever to the top. Insert the tapered end through the slot in the inboard (right) end of the drum.



4. The take-up fastener is designed to automatically take up any slack caused by stretching of the abrasive wrap. The abrasive wrap may stretch enough in use to allow the take-up lever to reach its lowest position so it no longer is able to maintain tension on the wrap. If this occurs, it will be necessary to reset the take-up lever by raising it, pushing the wrap end into the slot, and then releasing the clip lever.

Note: The drum was removed to show the inboard (right) take-up fastener.



NOTE: Take notice that for detail only the drum was removed to show the inboard (right) take-up fastener.

7. Machine Operation

Proper Abrasive Position

Position the abrasive in the slot with sufficient room between the inside of the slot and the tapered end of the wrap to allow it to be pulled into the drum as needed. If enough space is not left between the wrap and the inside of the slot the take-up fastener will not operate properly.

Abrasive Tension Adjustment

The abrasive wrap may stretch enough to allow the take-up lever to reach its lowest position. If this occurs, then the abrasive is no longer tensioned. To fix this reset the take-up lever by raising it. Push the abrasive into the slot and then release the clip lever.

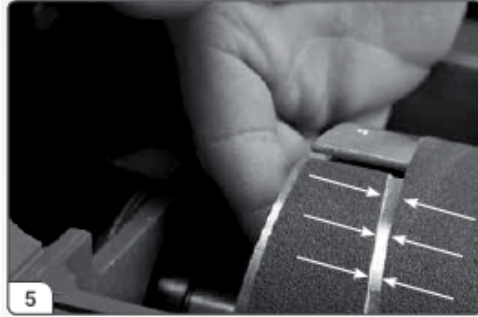

Maximizing Abrasive Longevity

We recommend a sandpaper cleaning stick to remove deposits and help extend the life of the abrasive.

1. To use the cleaning stick, operate the sanding drum with the dust cover open and dust collection on.
2. Hold the cleaning stick against the rotating drum and move it along the drum surface.
3. Use a brush to remove any cleaning stick remnants before resuming operation.

ALWAYS WEAR EYE PROTECTION WHILE PERFORMING ABRASIVE CLEANING. TAKE ALL PRECAUTIONS TO AVOID ANY CONTACT WITH HANDS OR CLOTHING.

OPERATING THE SANDER

Your sander will be able to perform an infinite variety of sanding projects all designed to your specifications. With some time and experimentation the proper setting and technique for each job will become apparent.

DRUM DEPTH OF CUT

Determining the depth of cut is the most important operating procedure decision. It may take some experimentation to determine the proper depth of cut. The crucial variables to keep in mind are abrasive grit, type of wood, project type, and conveyor feed rate. We recommend practicing on a scrap of wood prior to sanding a project.

Depth Scale Operation

The depth scale (see opposite picture) measures the distance between the conveyor table and the bottom of the sanding drum. The sanding head must be parallel to the conveyor bed surface.

1. To calibrate the depth scale, loosen the two screws holding the scale. Lower the drum (with abrasive installed) until the drum touches the conveyor belt.
2. Slide the scale to align with the pointer at the "0" mark. Tighten the two screws holding the scale.

An optional DRO (digital read out) for depth is available (see opposite picture). This offers the most precise reading of sanded thickness and allows for accurate repeatability of a thickness. Great when making parts that must be an exact thickness or when matching a thickness.

1. To operate, turn ON and select standard inch "in" or metric millimeter "mm".
2. Lower drum, with abrasive installed, until it touches the conveyor belt. Press "zero" button to calibrate.

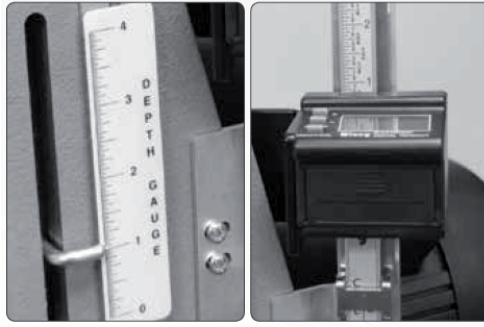

Using Thickness Gauge

Another method to set depth of cut is to use the thickness gauge attached to the inboard (right) side of the sander (see opposite picture). The gauge must be adjusted to the same height as the abrasive in use.

1. Place a flat piece of scrap stock under the drum with the abrasive in place. Lower the drum until the abrasive lightly touches the scrap piece of stock.
 2. Without changing the height, place the scrap stock under the thickness gauge. Adjust the bottom of the gauge by loosening the large nut and rotating the gauge up or down until it lightly touches the scrap piece of stock.
 3. Tighten the large nut. Now the stock can be placed under the thickness gauge and the drum lowered until the gauge lightly touches the stock to be sanded. By using this method the stock does not need to be carried under the drum to set depth of cut.
- A good rule of thumb when sanding is to place the stock under the drum and lower the sanding head until the stock is in contact with the drum but the drum can still be rotated by hand. Normally as the depth of cut is adjusted the handle will be rotated no more than a third of a turn at any time. INTELLISAND will help with this process.

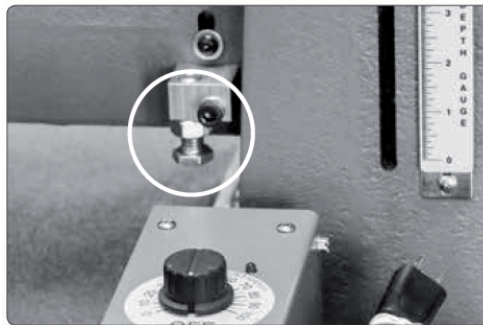

Using the DRO

Specifications

- Resolution: Decimal = .005 in. Fraction = 1/32 in. Metric = 0.1 mm
- Accuracy: Decimal = +/- .0025 in. Fraction = +/- 1/500 in. Metric = +/- .05 mm
- Battery: 2 AAA (not included)
- Functions:
- Constant memory retains calibration even when OFF
 - Incremental measuring mode
 - Absolute measuring mode
 - Millimeter, Inch and Fraction readout
 - Auto shut off



Button Reference and Use

It is helpful to familiarize these buttons and their purpose with the Wixey DRO

ON/OFF and CALIBRATION



- PUSH MOMENTARILY TO TURN OFF AND ON
- HOLD FOR 3-5 SECONDS TO ENTER CALIBRATION MODE. THE "ABS IN" FLASHES
- TO CHANGE THE DISPLAY VALUE FROM 0.000 USE THE + OR - BUTTONS.



- A SHORT PRESS INCREASES ONE DIGIT. HOLDING THE BUTTON COUNTS FAST.
- PRESS THE ON/OFF BUTTON MOMENTARILY TO SET THE CALIBRATION VALUE. THE "ABS IN" WILL STOP FLASHING

IN/MM

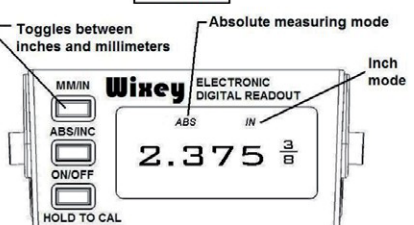

Labels: Toggles between inches and millimeters, Absolute measuring mode, Inch mode

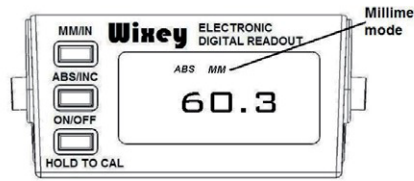

Label: Millimeter mode

ABS/INC

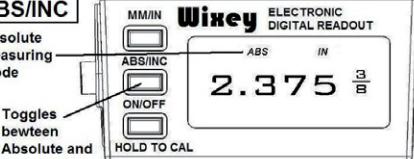

Label: Absolute measuring mode

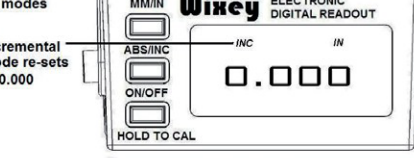

Labels: Toggles between Absolute and Incremental modes, Incremental mode re-sets to 0.000

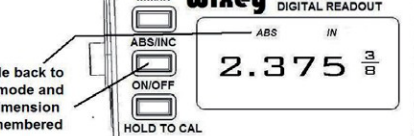

Label: Toggle back to ABS mode and the dimension is remembered

Calibration

There are three typical variations of calibration. The first variation (Type 1) is for the DRO to show the sanded thickness of the material. The second variation (Type 2) is to show how much stock is being removed with each pass of the sander. Another method (Type 3) to show the amount of material being removed per pass without recalibrating the Type 1 setting.

Type 1 Calibration ABS:

Calibration for the DRO to show sanded thickness (Type 1). Calibration is quick and easy and requires no extra measuring device. Make sure the machine is turned OFF and power is disconnected!

1. Wrap the sanding drum with the desired grit abrasive.
2. Lower the sanding drum until it lightly touches the conveyor belt.
3. Turn "ON" the DRO.
4. Hold the "CAL" button 3 seconds until "0.00" appears.



Type 2 Calibration ABS:

Calibration for the DRO to show stock removed per sanding pass (Type 2). Calibration is quick and easy and requires no extra measuring device. Make sure the machine is turned OFF and power is disconnected after the first step!

1. Sand a test piece of stock until it is flat and uniform on both sides.

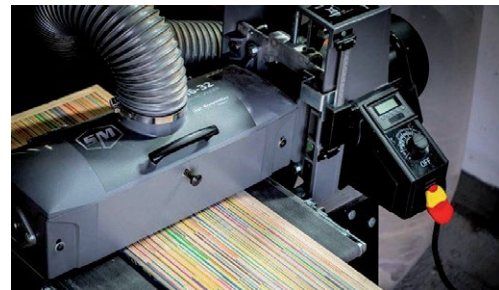

2. Turn the Sander OFF and disconnect power to sander.
3. Position the sanding drum (with abrasive still wrapped on drum) on the test piece until the drum is lightly touching the test piece.
4. Press and hold the "CAL" button for 3 seconds until "0.00" appears.



Type 3 Calibration INC:

This method allows saving the original calibration from Type 1 and confirming the amount of material being removed per pass.

1. Make one pass sanding your stock. Without changing the drum height press the "ABS/INC" button to read "0.00". This changes the readout from "ABS" to "INC" and zero's the readout on top of the just sanded piece. Now the readout will show the amount of stock removed per sanded pass in "INC" mode.

2. To change back to the original (Type 1) calibration press the "ABS/INC" button to change back to "ABS" mode.

NOTE: When changing the abrasive wrap to a different grit the DRO must be recalibrated for the change of drum diameter with the new grit abrasive!

NOTE: When setting the depth of cut, never exceed the thickness of the grit for stock removal.

CONVEYOR AND SPEED RATE

After the depth of cut has been determined, selecting the proper feed rate is essential. For finish sanding the best finish is usually achieved with a slow to moderate feed rate. Faster feed rates can be used as long as the machine is not over-stressed.

When finish sanding with grits finer than 80, the best finish can usually be obtained if INTELLISAND does not engage. If INTELLISAND does slow the conveyor when finish sanding, it is best to make another sanding pass without changing the thickness setting and sand again

Note: INTELLISAND will automatically adjust the conveyor feed rate if an excess load is detected. This prevents excessive gouging, reduces the risk of burning and protects the machine from overload or stalling. The red light by the adjustment knob will come on when INTELLISAND is operating. When the load is decreased, INTELLISAND will automatically increase the feed rate to the pre-selected speed.

Stock Feeding Operation

Rest and hold the stock to be sanded on the conveyor table. Allow the conveyor to carry the stock into the drum. Once the stock is halfway through, reposition yourself to the outfeed side of the machine to control the stock as it exits the unit.

Stock Feeding Maximum Performance

The versatility of this drum sander allows it to be used for a wide range of tasks. Learning to use the multiple controls to make adjustments will allow you to fine tune the machine for maximum results.

• Sanding stock wider than the drum

When sanding stock wider than the drum the fast lever will be very useful (see picture). Wide stock requires extra space between the drum and the conveyor on the outboard (left) edge. The extra space prevents ridge lines from developing along the part that extends beyond the drum.

Adjusting the fast lever approximately half-way between the full upright and full downright position allows for easy alteration of the drum position in relationship to the conveyor without changing the initial drum alignment. It is a good idea to test a scrap piece of stock prior to sanding. If a line or ridge is still visible after adjusting the fast lever additional adjustments can be made to the drum alignment. After sanding stock wider than the drum the fast lever should be adjusted back to the original position. The fast lever should be put into the up position.

Note: The fast lever raises the inboard (right) side of the table .003. Never tighten the bolts all the way down. The fast lever should always be able to be moved back and forth between an up/down position. The bolts should be tightened, but not so tight that the fast lever doesn't move.



• Sanding multiple pieces simultaneously

When sanding multiple pieces at once, make sure to stagger the pieces across the width of the conveyor belt. This position provides better contact with the tension rollers. It is best to only process pieces that are all of a similar thickness. If there is a thickness difference, the thinner pieces may not come in contact with the tension rollers and may slip on the conveyor belt.

• Sanding Imperfect or Tall Stock

To avoid bodily injury, take special care when sanding stock that is twisted, bowed or otherwise varied in thickness from end to end. If possible, support such stock as it is being sanded to keep it from slipping or tipping. Use extra roller stand, assistance from another person, or hand pressure on the stock to minimize potentially hazardous situations. Special attention is needed as the stock exits the machine. Special attention is needed as the stock exits the machine.

• Stock Feeding Position and Angle

Positioning the stock at an angle will allow the most effective stock removal and least loading on the abrasives. Feeding stock straight through yields the widest sanding capacity and least noticeable scratch pattern. Some pieces because of their dimensions will need to be fed into the sander at a 90-degree angle (perpendicular to the drum). However, even a slight offset angle of the stock can provide for more effective sanding. Final pass sanding should be done while following the grain pattern.

TENSION ROLLER PRESSURE

The tension roller pressure is factory set and should be adequate. However, the pressure of each roller can be adjusted as needed. To increase the tension, turn the tension adjusting screw clockwise 1/4 revolution at a time. To decrease tension, turn the adjusting screw counter clockwise 1/4 revolution at a time.

Note: Too little pressure can result in slippage of stock on conveyor belt or kick-back. Too much tension can cause snipe when drum sanding.

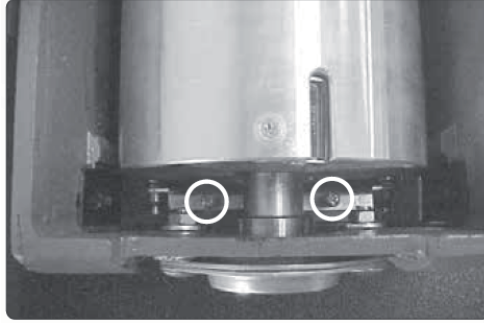

TENSION ROLLER CONTACT ADJUSTMENT

The tension rollers are factory set for the most versatile use.

1. If necessary, to adjust tension roller contact, loosen the four socket head screws holding the tension roller brackets (two per side; front and back – shown in picture).
2. Have abrasive wrapped on drum.
3. With machine unplugged, lower sanding drum until it rests on conveyor belt.
4. Raise drum 2 to 3 revolutions.
5. Tighten the four socket head screws (two per side; front and back).
6. Raise drum up, off of the conveyor belt.
7. Set drum for proper sanding height and process stock.



CONVEYOR BELT TENSION

Insufficient belt tension will cause slippage of conveyor belt on the drive roller. The conveyor belt is too loose if it can be stopped by placing your hand directly on the conveyor belt.

Excessive belt tension can result in bent rollers, premature wearing of the bronze bushings or conveyor belt.

To adjust the conveyor belt, first adjust the take-up screw nut on both sides of the conveyor to obtain approximately equal tension on both sides.

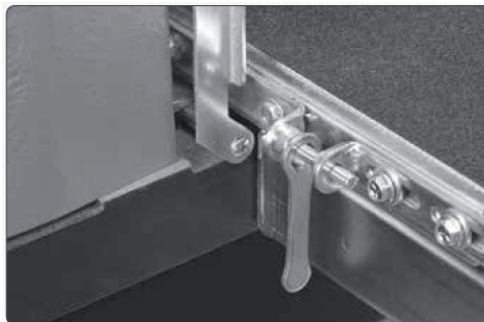

CONVEYOR BELT TRACKING

Belt tracking adjustments are made while the conveyor belt is running.

After the proper belt tension is obtained, turn the conveyor on and set it at the fastest speed setting. Watch for a tendency of the conveyor belt to drift to one side of the conveyor.

To adjust the belt tracking, tighten the take-up screw nut on the side the belt is drifting toward, and loosen the take-up screw nut on the opposite side.

Adjusting the take-up screw nuts does not affect the belt tension. Note: Adjust the take-up screw nuts only 1/4 turn at a time. Allow the belt to react to the adjustments before proceeding further. Avoid over-adjustments.

8. Maintenance

Monthly Maintenance

- Lubricate conveyor bushings and check for wear.
- Lubricate with a dry lubricant spray all of the moving parts.
- Clean dust from conveyor belt.
- Check all set screws for tightness.
- Clean drum and abrasives if necessary.

Replacing Conveyor Belt

To replace the conveyor belt, the conveyor assembly must be removed from the machine.

Unplug the machine from the power source!

1. Raise the drum carriage to its highest position. Unplug main drive motor from receptacle on the machine.

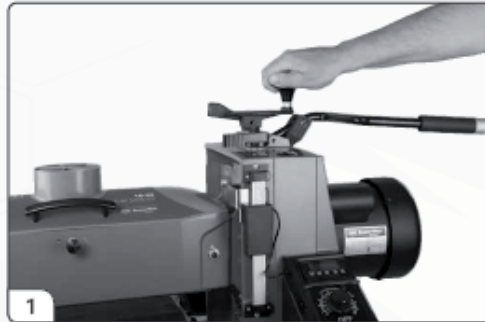

2. Loosen the conveyor take-up screws to relieve belt tension and slide the drive roller fully inward.



3. Remove the two hex bolts on the inboard (right) side that attach the conveyor assembly to the base.



4. Remove the two nuts and washers from outboard (left) side. Lift the conveyor and remove it from the sander. Set conveyor on motor side. Avoid tearing the belt on any edges underneath the conveyor bed during removal. Reverse the procedure for re-installation.



Cleaning the Sander

The sander may need to be cleaned more frequently depending upon frequency of use. The drum and the conveyor belt need to be clean. Allowing excess build-up of dust and debris can adversely affect performance and increase the likelihood of slippage on the conveyor belt. Sweep the conveyor belt clean after all operations. When cleaning dust from the drum leave the dust collection system on.

Accessories

Recommended accessories can be found on the IGM website.

Warning! Installation of unapproved accessories can cause damage to the machine and serious injury. Only use accessories recommended by IGM for this machine.

Abrasives

Up to date offer at www.igmttools.com

9. Troubleshooting

Any operating problems will likely occur during the period of becoming familiar with the sander. If you are experiencing a problem affecting the machine's performance, check the following listings for potential causes and solutions. Also review the previous sections in this manual on setting up and operating your machine.

TROUBLESHOOTING GUIDE: MOTOR

Problem	Possible Cause	Solution
Motor does not start	Main power cord unplugged from receptacle	Plug in primary power cord
	Drum motor cord unplugged from receptacle near powerfeed motor	Plug in drum motor cord to receptacle on the machine
	Circuit fuse blown or circuit breaker tripped	Replace fuse or retrip breaker (after determining cause)
Brush motor overloads	Inadequate circuit	Check electrical requirements
	Machine overloaded	Use slower feed rate; reduce depth of cut
Conveyor motor oscillates	Motor not properly aligned	Loosen housing bolts and hex screw holding the coupler to drive roller
	Shaft collar or bushing worn	Replace shaft collar or bushing
	Drive roller bent	Replace drive roller
Drum motor or Conveyor gear motor stalls	Excessive depth of cut	Reduce depth of cut; reduce feed rate

TROUBLESHOOTING GUIDE: CONVEYOR

Problem	Possible Cause	Solution
Conveyor drive rollers run intermittently	Shaft coupling loose	Align shaft flats of gear motor and drive roller; tighten shaft coupling set screws
Conveyor belt slips on drive roller	Improper conveyor belt tension	Adjust belt tension
	Excessive depth of cut	Reduce depth of cut; reduce feed rate
Stock slips on conveyor belt causing gouging	Excessive depth of cut	Reduce depth of cut
	Excessive feed rate	Reduce feed rate
	Dirty or worn conveyor belt	Clean or replace conveyor belt
Conveyor motor stalls	Belt out of adjustment	Readjust belt
	Roller bushings elongated due to excessive wear	Replace bushings

TROUBLESHOOTING GUIDE: MACHINE

Problem	Possible Cause	Solution
Drum height adjustment works improperly	Improper adjustment of height control	Readjust height control
Knocking sound while running	Bearing worn	Replace the bearing. Contact distributor
Sniping of wood (gouging near end of board)	Inadequate support of stock	Use roller stands to support stock
	Conveyor drive or driven rollers higher than conveyor bed	Readjust rollers
	Excessive tension roller pressure	Adjust rollers
Burning of wood or melting of finish	Feed rate too slow	Increase feed rate
	Excessive depth of cut	Reduce depth of cut
Conveyor motor stalls	Conveyor belt is too loose	Adjust belt tension
	Excessive depth of cut	Reduce depth of cut
	Wood slipping on conveyor due to lack of contact	Use alternate feeding procedure

19-38 - WIRING DIAGRAM

BU	blue
BN	brown
GNYE	green-yellow

	meaning of symbol
M	motor
S	switch
CB	control board
FR	filter
OT	outlet
CM	conveyor motor
F	fuse
CS	centrifugal switch

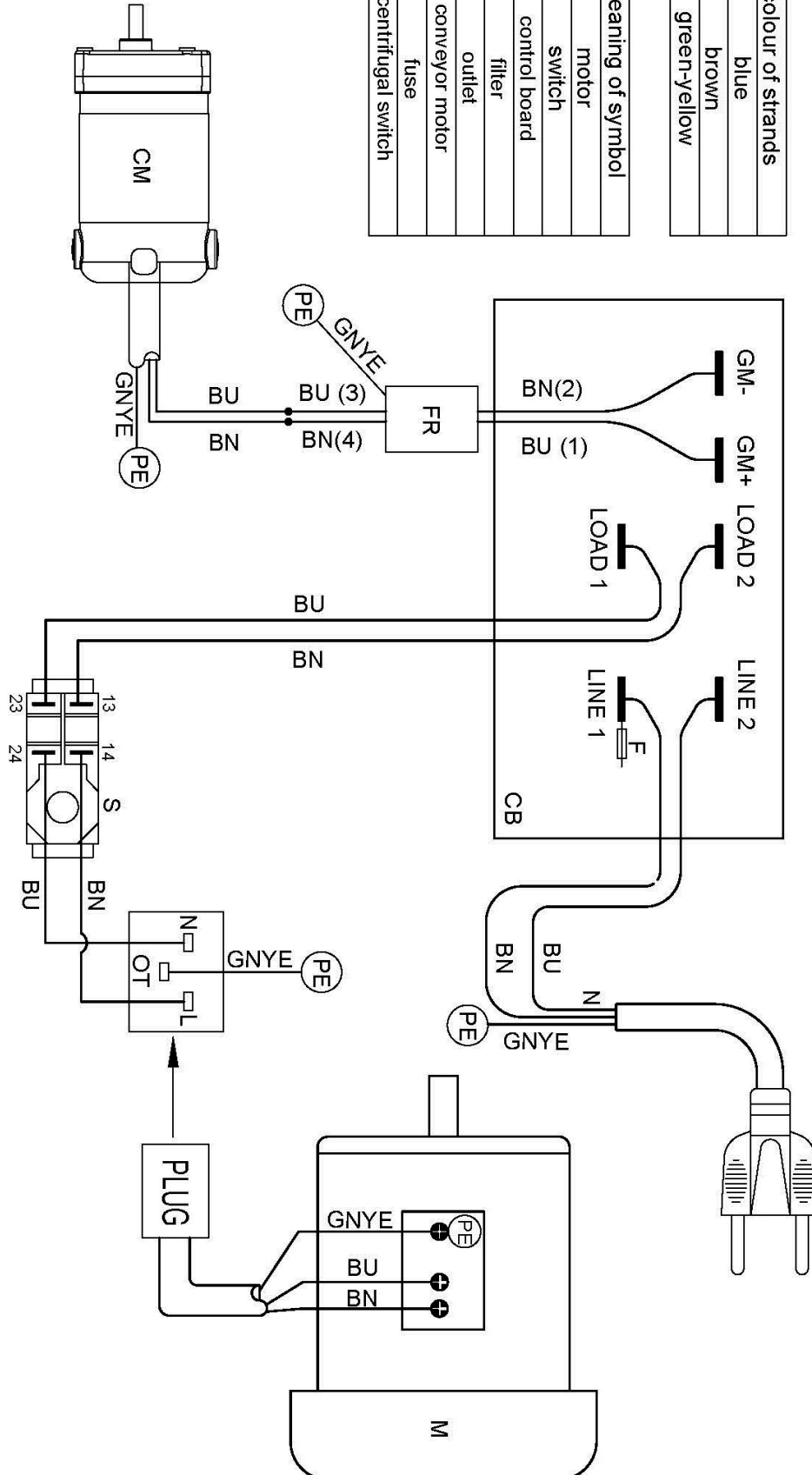

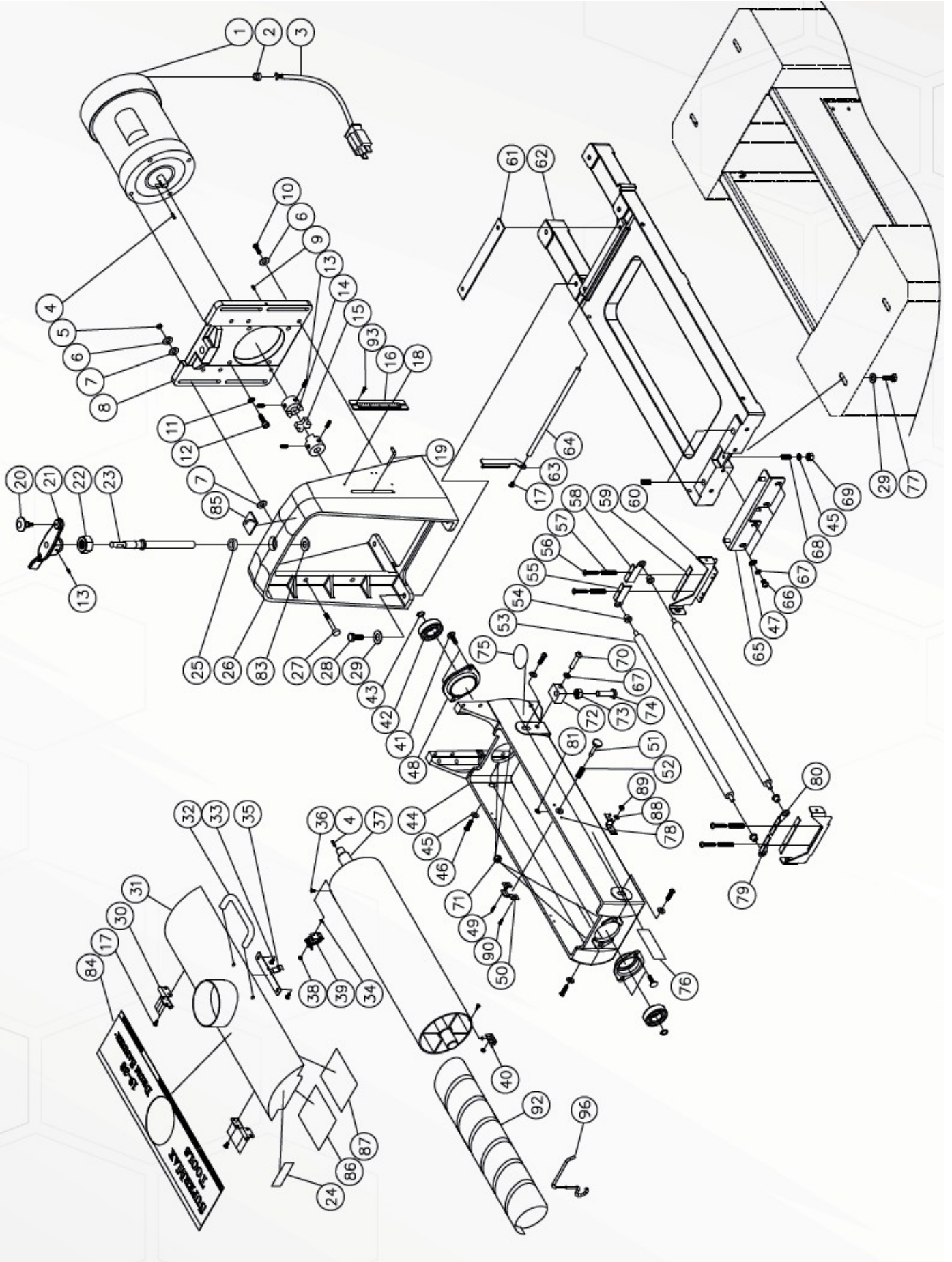

19-38 - PARTS LIST - HEAD ASSEMBLY

#	PART NO	DESCRIPTION	SIZE	QTY
1	480DS-101E	MOTOR		1
2	480BS-194-UK	STRAIN RELIEF, MOTOR	PG-11	
3	480DS-103E	MAIN CORD, MOTOR TO CONTROL BOX		1
4	480BS-104	KEY	3/16"SQX3/4"	2
5	480BS-105	NYLON INSERT LOCK NUT	5/16"-24	4
6	480BS-106	FLAT WASHER	5/16"	10
7	480BS-107	OILITE WASHER		8
8	480BS-108	MOTOR PLATE		1
9	480BS-109	SET SCREW	#8-32X1/4"	1
10	480BS-110	HEX CAP SCREW	5/16"-18X1-1/4"	6
11	480BS-111	LOCK WASHER	3/8"	4
12	480BS-112	SOCKET HEAD CAP SCREW	3/8"-16X1-1/2"	4
13	480BS-113	SET SCREW	1/4"-20X1/4"	5
14	480BS-114	COUPLING		2
15	480BS-115	COUPLING SPIDER		1
16	480BS-116	HEIGHT PLATE		1
17	480BS-117	SCREW, PHIL PAN HEAD	M4X0.7X6	9
18	480BS-118A	LABEL, DEPTH GAUGE (MM)		1
19	480BS-119	DEPTH GAUGE POINTER		1
20	480BS-120	KNOB		1
21	480BS-121	HEIGHT ADJUSTMENT HANDLE		1
22	480BS-122	NYLON INSERT LOCK NUT	5/8"-11	1
23	480BS-123	HEIGHT ADJUSTMENT SCREW		1
24	480BS-199	ROTATING DIRECTION LABEL		1
25	480BS-125	THRUST BEARING	51103	1
26	480BS-126	SHROUD		1
27	480BS-127	STUD		4
28	480BS-128	HEX CAP SCREW	3/8"-16X1-1/4"	4
29	480BS-129	FLAT WASHER	3/8"	8
30	480BS-130	HINGE		2
31	480DS-131A	DUST COVER		1
32	480BS-132	HANDLE		1
33	480BS-133	PAN HEAD MACHINE SCREW	#8X1/2"	2
34	480DS-134	LOCK WASHER	M3	2
35	480BS-135	DUST COVER LATCH		1
36	480DS-136	PHILLIPS FLAT HEAD SCREW	M3X0.5X10	2
37	480DS-137	SANDING DRUM		1
38	480DS-138	NYLON INSERT LOCK NUT	M3X0.5	2
39	480DS-139	INBOARD ABRASIVE FASTENER		1
40	480DS-140	OUTBOARD ABRASIVE FASTENER		1
41	480DS-141	CARRIAGE BOLT	5/16"-18X"	4
42	480DS-142	BEARING	6205LLU	2
43	480DS-143	C-RING	S25	2
44	480DS-144	DRUM CARRIAGE		1
45	480BS-145	FLAT WASHER	1/4"	5
46	480BS-146	ROUND SOCKET HEAD CAP SCREW	1/4"-20X1"	4
47	480BS-147	FLAT WASHER	5/16"	4
48	480DS-148	BEARING SEAT		2
49	480BS-149	HEX CAP SCREW W/ WASHER	#10-24X3/8"	1
50	480BS-150	DUST COVER CATCH		1
51	480BS-151	STUD		1
52	480BS-152	SPRING		1
53	480BS-153	TENSION ROLLER		2
54	480BS-154	BUSHING, OILITE		4
55	480BS-155	TENSION ROLLER BRACKET, INNER LEFT		1
56	480BS-156	SCREW	#8-32X1"	4
57	480BS-157	SPRING, TENSION ROLLER		4
58	480BS-158	TENSION ROLLER BRACKET, INNER RIGHT		1
59	480BS-159	PAD, BRACKET-TENSION ROLLER		2
60	480BS-160	BRACKET		2
61	480BS-161	PLATE		1
62	480BS-162	BASE		1
63	480BS-163	ADJUSTING PLATE		1
64	480BS-164	ADJUSTING ROD		1
65	480BS-165	HEIGHT ADJUSTING PLATE		1
66	480BS-166	ROUND SOCKET HEAD CAP SCREW	5/16"-18X1/2"	4
67	480BS-167	LOCK WASHER	5/16"	5
68	480BS-168	SPRING		3
69	480BS-169	NYLON INSERT LOCK NUT	1/4"-20	1
70	480BS-170	SOCKET HEAD CAP SCREW	M8X1.25X40	1
71	480BS-171	HEX NUT W/ WASHER	5/16"-18	4
72	480BS-172	BLOCK, MEASURING DEVICE		1
73	480BS-173	HEX NUT	M12X1.75	1
74	480BS-174	STOP BOLT		1
75	480BS-198	WARNING LABEL, POWER		1
76	480BS-195	WARNING LABEL, FINGER		2
77	480BS-177	HEX CAP SCREW	3/8"-16X3/4"	4
78	480BS-1106	SAFTY LUCK		1
79	480BS-179	TENSION ROLLER BRACKET, OUTER RIGHT		1
80	480BS-180	TENSION ROLLER BRACKET, OUTER LEFT		1
81	480BS-181	E-RING	E5	1
83	71632-124	WASHER, WAVE	D17	1
84	480DS-184	LABEL		1

#	PART NO	DESCRIPTION	SIZE	QTY
85	480BS-196	HEIGHT DIRECTION LABEL		1
86	480BS-186	MAINTENANCE LABEL		1
87	480BS-187	WARNING LABEL		1
88	480BS-1105	LOCK WASHER	#10	1
89	480BS-1104	HEX NUT	#10-24	1
90	480BS-1103	HEX CAP SCREW W/ WASHER	#10-24X1"	1
92	480BS-1102	ABRASIVE STRIP	#80	1
93	72550-197	SCREW, PHIL PAN HEAD	M4X0.7X12	2
96	635DS-280	FASTENER TOOL		1

19-38 - CONVEYOR AND MOTOR

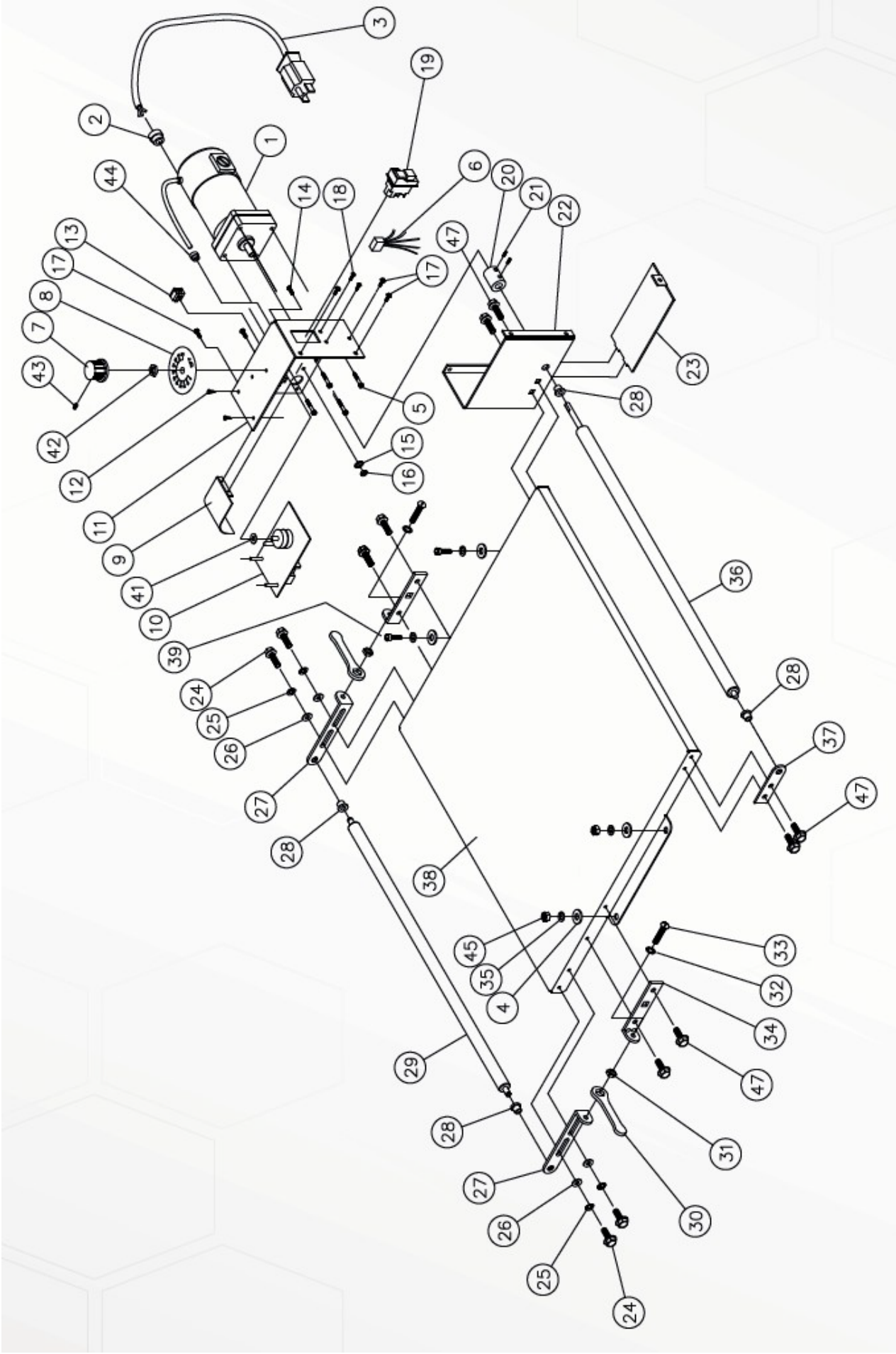

19-38 - PARTS LIST - CONVEYOR AND MOTOR

#	PART NO	DESCRIPTION	SIZE	QTY
1	480BS-201A	GEAR MOTOR	180 VDC	1
2	480BS-194-UK	STRAIN RELIEF	PG-11	1
3	72-5336-JG	POWER CORD		1
4	480BS-204	FLAT WASHER	5/16"	4
5	480BS-205	SOCKET HEAD CAP SCREW	#10-32X1/2"	4
6	2244PLUS--112E	EMC FILTER		1
7	480BS-207	KNOB		1
8	480BS-208	SPEED ADJUSTMENT LABEL		1
9	480BS-209	WIRING GUARD		1
10	480DS-210A	CONTROLLER		1
11	480DS-211A	CONTROL HOUSING BRACKET		1
12	480BS-212	PAN HEAD SELF-TAPPING SCREW	5/32"X1/2"	2
13	480BS-213	RECEPTACLE, MAIN CORD		1
14	480BS-214	SCREW	#10-32X1/2"	4
15	480BS-215	WASHER, LOCK-INT. TOOTH	#10	4
16	480BS-216	HEX NUT	#10-32	4
17	480BS-217	SCREW, HEX HEAD-SLOTTED	#10-32X3/8"	5
18	480BS-218	SCREW, PHIL PAN HEAD	#6-32X1/2"	2
19	635DS-356	SWITCH, ON/OFF		1
20	480BS-220	COUPLER, SHAFT		1
21	480BS-113	SET SCREW	1/4"-20X1/4"	4
22	480BS-222	BRACKET, BASE- CONTROLLER		1
23	480BS-223	COVER, BASE-CONTROL HOUSING		1
24	480BS-224	HEX CAP SCREW	1/4"-20X3/4"	4
25	480BS-225	WASHER, WAVE	1/4"	4
26	480BS-145	FLAT WASHER	1/4"	4
27	480BS-227	BRACKET, TAKE UP-SLIDE		2
28	480BS-154	BUSHING, OILITE		4
29	480BS-229	ROLLER, DRIVEN		1
30	480BS-230	WRENCH		2
31	480BS-231	HEX NUT	1/4"-20	2
32	480BS-232	WASHER, LOCK-INT. TOOTH	1/4"	2
33	480BS-233	SCREW, ROUND HEAD- SLOTTED	1/4"-20X1-3/4"	2
34	480BS-234	BRACKET, TAKE UP-BASE		2
35	480BS-167	LOCK WASHER	5/16"	4
36	480BS-236	ROLLER, DRIVE		1
37	480BS-237	BRACKET, SUPPORT-DRIVE ROLLER		1
38	480BS-238	BED, CONVEYOR		1
39	480BS-239	ROUND SOCKET HEAD CAP SCREW	5/16"-18X3/4"	2
40	480DS-240	BELT CONVEYOR, ABRASIVE (NOT SHOWN)		1
41	480BS-204	FLAT WASHER	5/16"	1
42	480BS-242	HEX NUT	5/16"-24	1
43	480BS-243	SLOTTED SET SCREW	#8-36X5/16"	1
44	PG-9	STRAIN RELIEF, GEAR MOTOR	PG-9	1
45	480BS-245	HEX NUT	5/16"-18	2
47	480BS-247	HEX CAP SCREW	1/4"-X1/2"	8

OPEN STAND ASSEMBLY

#	PART NO	DESCRIPTION	SIZE	QTY
1	480BS-501	LEG, LEFT		2
2	480BS-502	LEG, RIGHT (WITH TOOL HOLDER)		2
3	71632-303	TOP CROSS BRACE, LONG		2
4	71632-304	TOP CROSS BRACE, SHORT		2
5	71632-305	LOWER CROSS BRACE RAIL, LONG		2
6	71632-306	LOWER CROSS BRACE RAIL, SHORT		2
7	480BS-507	FLANGE NUT	5/16"	8
8	480BS-508	LEVELING FOOT		4
9	480BS-129	FLAT WASHER	3/8"	8
10	480BS-509	HEX NUT	3/8"-16	8
11	480BS-506	CARRIAGE BOLT	5/16"-18 X 5/8"	24

